

DAEWOO

20" LCD Television

MODEL NO : DSL-20D1T

Instruction Manual



PAL-I, II, PAL/SECAM-B/G, D/K, SECAM-L/L'/NTSC-AV
A2 / NICAM STEREO SOUND
TELETEXT
SCART / VIDEO / S-VIDEO / COMPONENT
MULTI-LANGUAGE OSD

Ver. 032302

SPECIAL NOTE FOR USERS IN GREAT BRITAIN

The appliance is supplied with a moulded three pin mains plug fitted with a 5 Amp fuse.

Should the fuse require replacement, it must be replaced with a fuse rated at 5 Amp and approved by ASTA or BSI to BS1362.

The plug contains a removable fuse cover that must be refitted when the fuse is replaced.

In the event of the fuse cover being lost or damaged, the plug must not be used until a replacement cover has been obtained. Replacement fuse covers can be purchased from your nearest electrical dealer and must be the same colour as the original. If the moulded mains plug is unsuitable for the socket outlet in your home or is removed for any other reason, then the fuse should be removed and the cut off plug disposed of safely to prevent the hazard of electric shock. There is a danger of electric shock if the cut off plug is inserted into any socket outlet. If a

replacement plug is to be fitted, please observe the wiring code shown below. The wires in the mains lead are coloured in accordance with the following code :

Blue - Neutral Brown - Live

As these colours may not correspond to the coloured markings identifying the terminals in your plug, proceed as follows:

- The wire coloured BLUE must be connected to the terminal marked with the letter N or coloured BLUE or BLACK.
- The wire coloured BROWN must be connected to the terminal marked with the letter L or coloured BROWN or RED.

WARNING : Do not connect either wire to the earth terminal, which is marked with the letter E or by the earth symbol, or coloured green or green and yellow.

CAUTION

WARNING : To reduce the risk of fire or electric shock hazard, do not expose this appliance to rain or moisture.

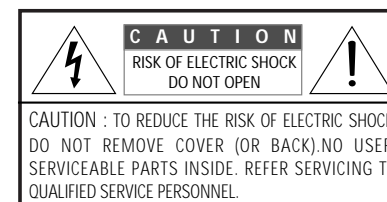

The lightning flash with arrow-head symbol, within an equilateral triangle, is intended to alert the user to the presence of uninsulated "dangerous voltage" within the product's enclosure the may be of sufficient magnitude to constitute a risk electric shock.



The exclamation point within an equilateral triangle is intended to alert the user to the presence of important operating and servicing instructions in the literature accompanying the product.

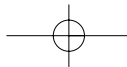

SAFETY PRECAUTIONS

1. CLEANING

Unplug this TV equipment from the AC power outlet before cleaning. Do not use liquid cleaner or aerosol cleaners. Use a soft and damp cloth for cleaning.



2. ATTACHMENTS

Do not use attachments not recommended by the TV equipment manufacturer as they may result in the risk of fire, electric shock or other injury.



3. WATER AND MOISTURE

Do not place this TV equipment near water, for example, near bathtub, kitchen sink, laundry tub, in a wet basement, or near a swimming pool, or the like.

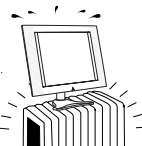

4. HEAT

Keep the TV equipment away from the heat sources such as radiator, heater, stoves and other heat-generating products

5. SETTING

Do not place this TV on unstable cart, stand, or table. Placing the TV on an unstable base can cause the TV to fall, resulting in serious personal injuries as well as damage to the TV. Use only a cart, stand, bracket or table recommended by the manufacturer or salesperson.



6. WALL OR CEILING MOUNTING

When mounting the product on a wall or ceiling, be sure to install the product using the designated mounting tool according to the method recommended by the manufacturer.



7. POWER SOURCES

This TV equipment should be operated only from the type of power source indicated on the marking label. If you are not sure of the type of power supplied to your home, consult your TV dealer or local power company.

Warning: This TV equipment MUST BE earthed.



8. PIXEL

The LCD panel is a very high technology product with 921,600 thin film transistors give you fine picture details. Occasionally, a few non-active pixels may appear on the screen as a fixed point of blue, green or red please note that this does not affect the performance of your product.

CONTENTS

IMPORTANT SAFEGUARDS	2
SUPPLIED ACCESSORIES	2
FUNCTIONAL OVERVIEW	3
PREPARATION	
Inserting Batteries into the Remote Control Unit.....	5
Aerial connection	
Mains connection	
Connecting external equipment	
INSTALLATION	
Language selection.....	8
Automatic Tuning of TV Channels	
Programme Editing	
Manual Setup	
DAILY USE	
Switching On and off	12
Status (Recall)	
Programme Selection	
Picture Control	
Sound Control	
Special Features	
Sleep	
Still	
Hotel mode	
Teletext	
WALL/ARM MOUNTING	19
TROUBLESHOOTING	20
PRODUCT SPECIFICATIONS	21

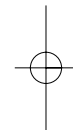

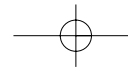

IMPORTANT SAFEGUARDS

■ Location

Heat, Moisture, Dust, Vibration

Position your set so that bright light or sunlight doesn't fall directly onto the screen.

Care should be taken not to expose the set to any unnecessary vibration, moisture, dust or heat.

Do not expose the set to dripping or splashing.

Ventilation

Also ensure that the set is placed in a position to allow a free flow of air.

Do not cover the ventilation openings on the back cover.

Mounting

This set can be positioned by using the table top stand or wall mounting bracket.

When you install the set using the wall mounting bracket, fix it carefully so it is secure.

■ Object Entry:

Do not insert foreign objects, such as needles and coins, into the ventilation openings.

■ Lightning striking

You should disconnect your set from the mains and the aerial system during thunderstorms.

■ Cleaning

Unplug the set from the mains before cleaning. Dust the set by wiping the LCD screen and the cabinet with a soft, clean cloth.

If the screen requires additional cleaning, use a clean, damp cloth.

Do not use liquid cleaners or aerosol cleaners.

Do not rub or strike the LCD with anything hard as this may scratch, or damage the LCD permanently.

■ Service

Never remove the back cover of the set as this can expose you to high voltage and other hazards.

If the set does not operate properly, unplug it and call your dealer.

SUPPLIED ACCESSORIES

Make sure the following accessories are provided with the product.

- Remote controller / AC Power cord / Instruction manual

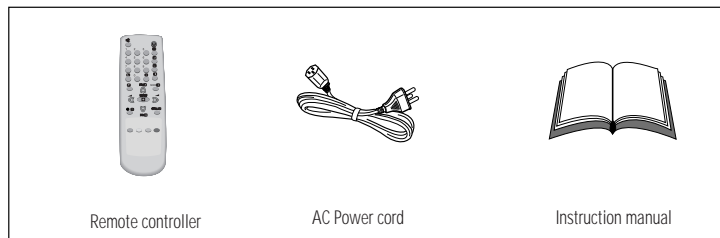

Remote controller

AC Power cord

Instruction manual

NOTE : Batteries are not included.

FUNCTIONAL OVERVIEW

■ Front

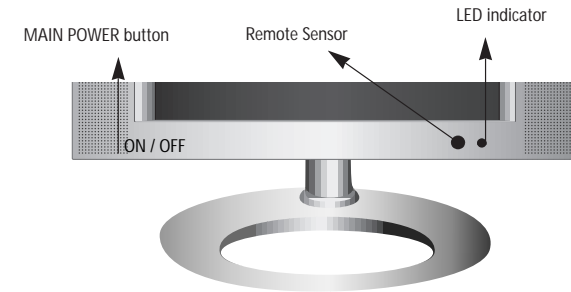

■ Side

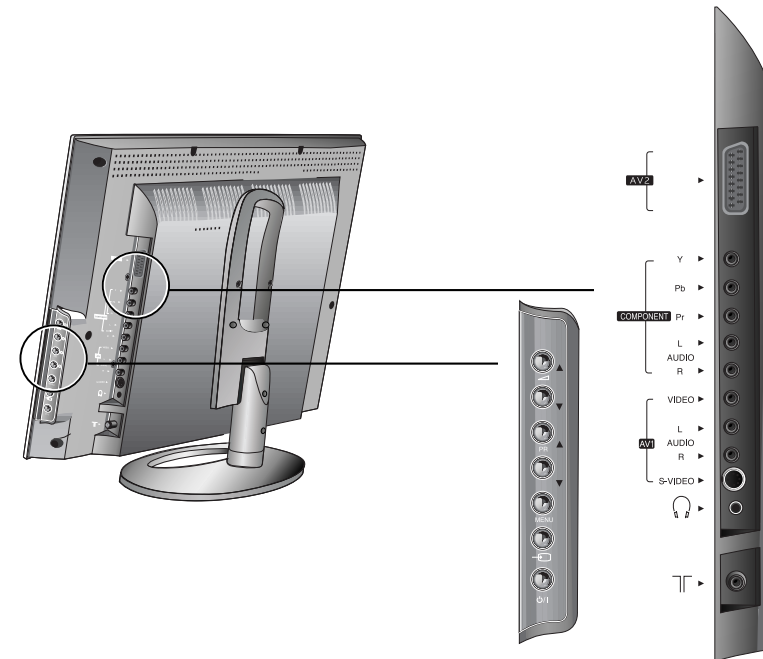

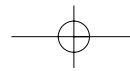

FUNCTIONAL OVERVIEW

■ Remote Control

[] : Teletext function

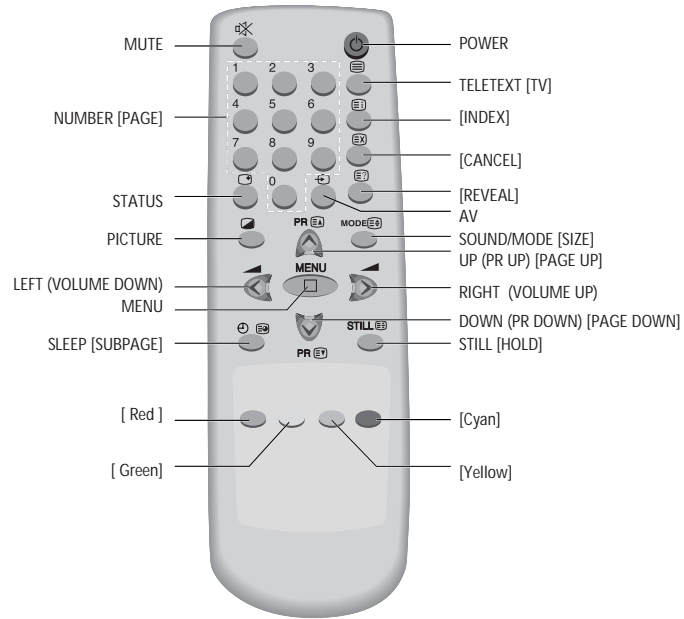

PREPARATION

■ Inserting Batteries into the Remote Control Unit

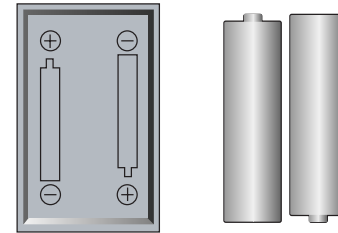

To load the batteries, turn the remote control handset over and open the battery compartment. Insert the batteries (two 1.5V, R03 or type AAA). Make sure that the polarity matches with the (+) and (-) marks inside of the battery compartment.

Note :

To avoid damage from possible battery leakage, remove the batteries if you do not plan to use the remote control handset for an extended period of time.

■ Mains Connection

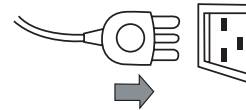

Plug the mains cable into the power socket with 100V-240V AC, 50/60 Hz.

■ Aerial Connection

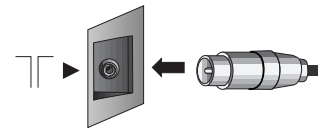

For better picture and sound quality, an effective aerial installation is most important. When using an outdoor aerial, it is usually connected to the set by means of 75 ohm coaxial cable.

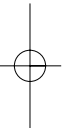

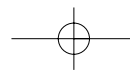

PREPARATION

■ Connecting external equipment

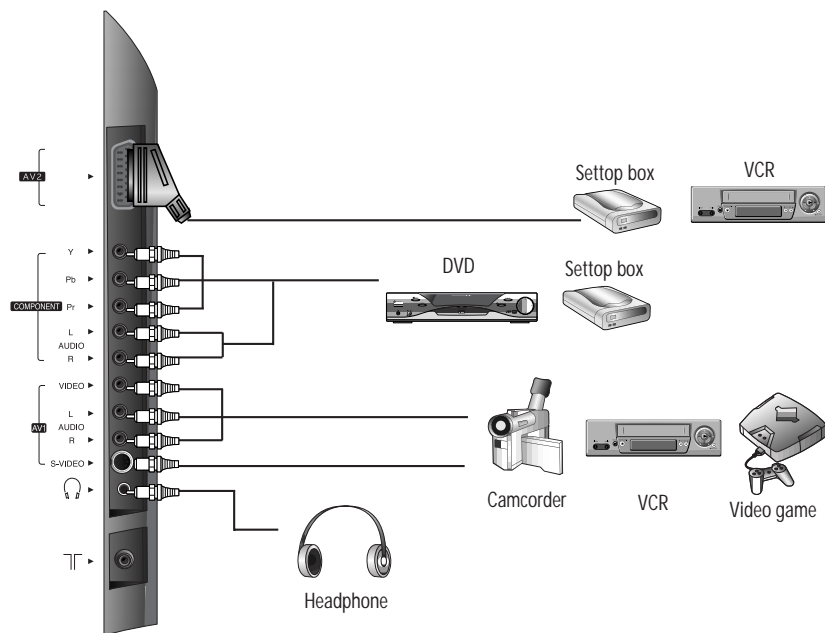

PREPARATION

TV/AV Mode Selection

Whenever the AV button is pressed, the on-screen display will be changed as shown:

TV → AV1(or AV1/S-video) → Component → AV2(or AV2/RGB) → TV →

Note :

If you wish to use only the aerial (RF) connection, then you should make use of PR 00 on the TV set for best performance to tune in and record from a set top box or VCR. When the TV SET is no signal, OSD(On Screen Display) appears on the screen.

AV Input Jack (AV1)

This jack has video / audio inputs. The jack is used to connect a Camcorder, VCR, Video game.

S-video Input Jack (AV1/S-video)

It has Y/C inputs. This jack is used to connect an S-Video Camcorder, S-video VCR.

Note :

The AV input Jack and S-video input Jack are shared connections with priority given to the S-video input Jack. When the S- video Jack is connected, the TV set switches automatically to AV1/S-video mode.

Do not connect both the AV Input Jack and S-video Input Jack .

Component Input Jack (Component)

It has Y/Pb(Cb)/Pr(Cr) inputs and audio inputs. It is used to connect a DVD player.

SCART Jack (AV2, AV2/RGB)

This jack has video / audio inputs and outputs, RGB inputs. It is used to connect a STB, VCR.

In most cases, the TV set switches automatically to AV2 mode, when the external equipment connected is in playback mode. If not, then use the AV button to select AV2.

In AV mode, you can change the TV programme number with the UP/DOWN button or the NUMBER button.

Headphone Jack

Insert the headphone plug(3.5 mm φ) into this jack. The sound from the speaker will be automatically cut off. You can control the headphone sound with the ◀/ ▶ button.



TV

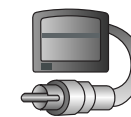

AV1

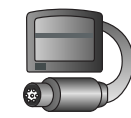

AV1/S-video

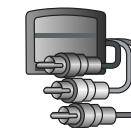

Component



AV2



AV2/RGB

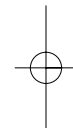

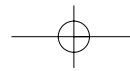

INSTALLATION

Language Selection

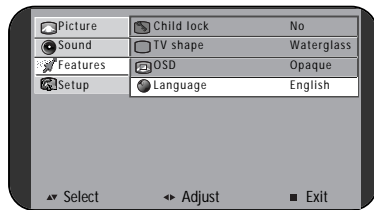

1. Press the MAIN POWER switch.
2. Press the POWER button, ▲/▼ button or NUMBER button. When you turn on the TV set for the first time, the Language menu for the on-screen display appears.
If not,
(1) Press the MENU button to call up the menu.
(2) Move the selection bar to the Feature menu with ▲/▼ button.
(3) Press the ► button.
(4) Move the selection bar to the Language with ▲/▼ button.

3. Press the ◀/▶ button to choose the language you want.
4. Press the MENU button to escape from menu.

Automatic Tuning of TV Channels

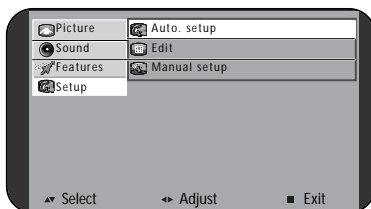

1. Press the MENU button to call up the menu.
2. Move the selection bar to the Setup menu with ▲/▼ button.
3. Press the ► button.
4. Place the selection bar on Auto setup and press the ► button.

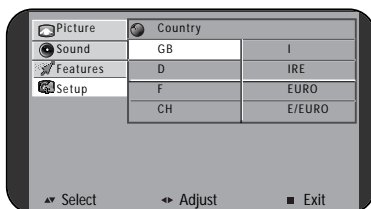

5. Place the selection bar on the country you require with ▲/▼ button.

GB : Great Britain	I : Italy
D : Germany	IRE : Ireland, Hong Kong, S/Africa
F : France	EURO : West and North Europe, N/Zealand, Middle-East, Asia, Africa
CH : China	E/EURO : East Europe, CIS, Vietnam

INSTALLATION

ENGLISH

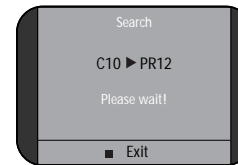

6. Press the ◀/▶ button.
Auto setup will begin, your stations will be located and stored.
7. Please wait until the tuning screen disappears.

Programme Editing

Call up the Edit menu from the Setup menu.

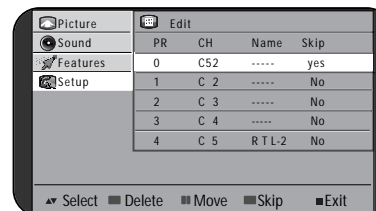

DELETING THE PROGRAMME

1. Position the selection bar to the programme to delete with the ▲/▼ buttons.
2. Press the RED button.

MOVING THE PROGRAMME

1. Select the programme to move with ▲/▼ button.
2. Press GREEN or YELLOW button to move the selected programme up or down to the desired programme number.

SKIPPING THE PROGRAMMES

1. Select SKIP "Yes" or "No" with the CYAN button.
2. The programme marked with SKIP "Yes" doesn't appear on screen when selecting a programme using the ▲/▼ button.

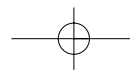

INSTALLATION

Manual setup

Call up Manual Setup from the Setup menu.

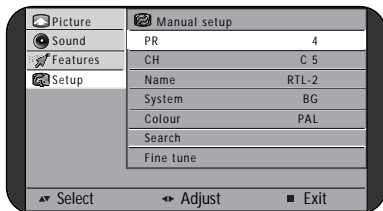

PROGRAMME NUMBER SELECTION

1. Position a selection bar to PR.
2. Press the ◀/▶ buttons to select a programme number you want.

TV SYSTEM SELECTION

If necessary, you can change the TV System.

1. Position a selection bar to System.
2. Select the TV system with ◀/▶ button.
 - BG** for Europe
 - DK** for East Europe, CIS
 - I** for Great Britain, Ireland
 - L** for France

CHANNEL SEARCH

▲/▼ Search

1. Position the selection bar to Search.
2. Press the ◀/▶ button to search up or down. Searching will stop at the next channel found and then the channel will be stored automatically.

Direct Search

You can directly locate a program by entering the channel number.

1. Position the selection bar to CH.
2. Select a channel with ◀/▶ button. The selected channel will be stored automatically.

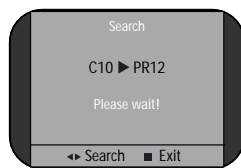

INSTALLATION

ENGLISH

FINE TUNING

If you are unable to get a good picture or sound because of a poor broadcast signal, it is possible to adjust the fine tuning.

1. Move the selection bar to Fine tune.
2. Press the ◀/▶ button to activate fine tuning up or down. It operates while the ◀/▶ button is being pressed. The change is stored automatically.

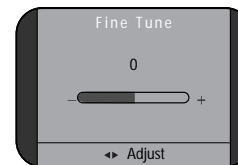

ENTER A STATION NAME

You can change an existing name, or enter a name where none exists.

1. Move the selection bar to Name.
2. Press the ▶ buttons to call up the Name menu.
3. Select the position with ▲/▼ button.
4. Use the ◀/▶ buttons to select the desired character :
A B C ...Z + . (blank) 1 2 ...9

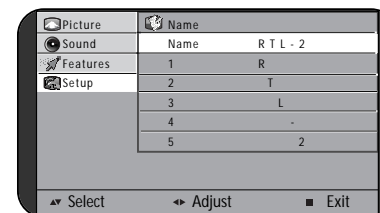

COLOUR STANDARD SELECTION

If necessary, you can change the Colour standard.

1. Position a selection bar to Colour.
2. Use the ◀/▶ buttons to select the desired Colour standard :
PAL ↔ SECAM ↔

NOTE : In the AV mode

PAL ↔ SECAM ↔ AUTOM ↔

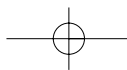

DAILY USE

■ Switching On and Off

SWITCHING ON

1. If the Indicator is not lit, then the TV set is powered off. You must press the MAIN POWER switch on the TV set.

The set will switch to stand-by mode and then the Indicator will illuminate in Red.

2. Press the POWER button, ▲ / ▼ button or NUMBER button.

The TV set will be switched on and then the Indicator change to Green.

SWITCHING OFF

1. Press the POWER button to return the set to its stand-by mode.

The Indicator will illuminate in Red.

2. Press the MAIN POWER switch to turn the TV set off completely.

Note :

If you don't use the set for extended periods of time, turn it off with MAIN POWER switch.

■ Status

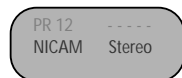

TV

The STATUS button is used to display the current status; TV/AV mode, Programme number, Channel Name, Sound mode.

DAILY USE

■ Programme Selection

The set has 100 programme numbers, PR00..PR99.

DIRECT SELECTION

The NUMBER buttons are used for direct programme selection. To select a two-digit programme, press the second numbered button within 2 seconds.

▲ / ▼ SELECTION

You can also select a programme by pressing step by step the ▲ / ▼ buttons.

■ Picture Control

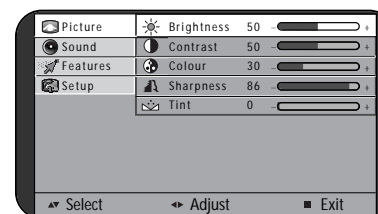

BRIGHTNESS, CONTRAST, COLOUR, SHARPNESS, TINT CONTROL

1. Call up the Picture menu.
2. Select and adjust the level of each function: "Brightness", "Contrast", "Colour", "Sharpness". "Tint" is displayed only when receiving a NTSC signal. The adjusted levels are stored automatically in Favourite mode.

SMART PICTURE SELECTION

When you press the PICTURE() button repeatedly, you can call up four pictures settings:

Normal → Bright → Dark → Favourite → Normal →

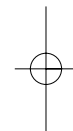

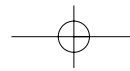

■ Sound Control

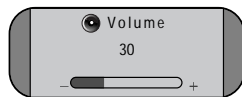

VOLUME CONTROL

Adjust the volume with the ◀ / ▶ buttons.

MUTE

Pressing the MUTE button turns the sound off.

The MUTE symbol will be displayed.

The sound returns if the button is pressed once more.

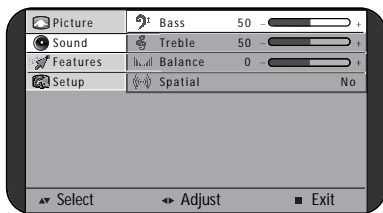

SOUND CONTROL

Call up the Sound menu.

Bass - Use this to adjust the low tone.

Treble - Use this to adjust the high tone.

Balance - Use this to adjust sound balance between the left and right speakers.

Spatial - If you select "Yes", the Spatial sound effect is available.

SOUND MODE

Stereo/Mono sound selection

When receiving a Stereo programme, Stereo mode is automatically selected. In Stereo reception if you are unable to get good sound quality due to poor reception, you can force a change from Stereo to Mono transmission by pressing the MODE button.

Then the program status display indicates (Mono).

To return back to Stereo, press the MODE button again.

The setting can be individually selected for each PR number.

Language Selection

When receiving a bilingual programme, Sound 1 mode is automatically selected.

The MODE button allows you to toggle between the first and second language.

The program status display will indicate "Sound 1", "Sound 2" or (Mono).

Note :

When receiving a NICAM signal, "NICAM" will be displayed.

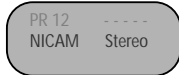
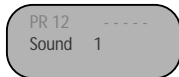
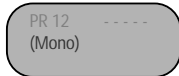
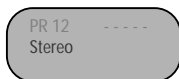

■ Special Features

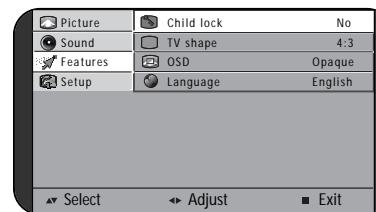

Call up the Feature menu.

CHILD LOCK

The set is child-locked by selecting "Yes".

You can prevent the use of the TV set without the remote control.

NOTE : When a Child lock is activated, the LED will be blanking the red and green in Stand-By mode in every second.

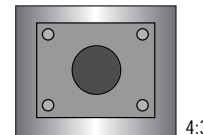

4:3

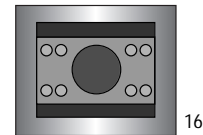

16:9

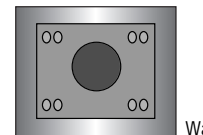

Waterglass

TV Shape (Aspect ratio) Control

The preferred mode can be forced by selecting.

The following picture formats are available:

4:3 → 16:9 → Waterglass → 4:3 →

Note :

Waterglass is used to fit a picture with 16:9 format on a 4:3 screen.

OSD(On-screen Display) Background

If you select Translucent, the OSD back-ground appears translucent .

If you select Opaque, the OSD back-ground appears opaque.

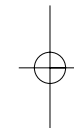

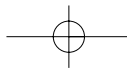

DAILY USE

■ Sleep

By pressing the SLEEP button repeatedly, you can select one of the following setting:

Sleep 0 → Sleep 30 → Sleep 60 → Sleep 90 → Sleep 120 → Sleep 0 →

The set will turn off after the time you select.

Note :

If a broadcast signal is not present for about 10 minutes, the set will be automatically turned to stand-by mode.

■ Still

The STILL button allows you to freeze the picture at anytime. To return to normal viewing, press the STILL button again.

■ Hotel mode

In the HOTEL mode, the Setup menu is not displayed and the Volume control is limited by half.

1. Press the RED, GREEN, YELLOW, CYAN, POWER button in sequence within 3 second.
2. Press the POWER button.
3. Repeat the above procedure 1 and 2 to exit from the HOTEL mode.

DAILY USE

■ Teletext

SWITCHING TELETEXT ON/OFF

Press the TELETEXT button.

The index page or the page viewed last will appear.

Press the TELETEXT button again to return to the TV mode.

COLOUR BUTTONS IN TOP/FLOF TELETEXT

A red, green, yellow and Cyan field is shown at the bottom of the screen.

If TOP or FLOF Teletext is transmitted by the station, pressing the corresponding colour button R/G/Y/C on the remote controller, you can select the desired page easily.

SELECTING PAGES

The NUMBER buttons are used to enter a page number. The selected page number appears at the top of the screen and the page appears after a short time. The ▲ / ▼ buttons increase or decrease the current page number by 1.

INDEX PAGE

You can switch directly to the programme preview (with TOP text) or the overview page of the station you are currently viewing by pressing the INDEX button.

PAGE HOLD

Several sub pages can be combined under a page number and are scrolled at an interval determined by the television station. The presence of sub pages is indicated by, for example, 3/6 beneath the time, which means that you are looking at the 3rd page of a total of 6 pages. If you want to look at a subpage for a longer period of time, press the HOLD button.

The HOLD symbol appears and the contents of the subpage shown are kept on the screen and no longer updated or switched to other subpages.

Pressing the HOLD button again, the current subpage appears.

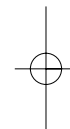

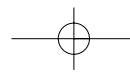

DAILY USE

CALLING UP SUBPAGE DIRECTLY

Pressing the SUBPAGE button, "S - - -" appears.

Enter the subpage number that you want to call up with the NUMBER button, for example, the 2nd page, sequence 0002.

The desired subpage will eventually be displayed on the screen and holds it there.

Meanwhile whilst you are waiting, it is possible to go back to the TV picture by pressing the CANCEL button on the remote and after a while, press the CANCEL button again to revert back to the saved Teletext sub page.

WATCHING TV DURING TELETEXT MODE

Some pages are continually updated, for example, stock market reports, sports announcements, and the latest news.

If you want to watch television and stay informed at the same time, press CANCEL button.

The regular programme is still visible and the Teletext page number appears at the top of the screen.

Pressing the CANCEL button, the Teletext page appears with the updated information.

REVEAL ANSWER

This function can be used on certain pages to reveal the solution of riddles.

Press the REVEAL button to reveal a hidden answer and press again to hide it.

DOUBLING CHARACTER SIZE

Repeatedly pressing the SIZE button doubles the character size in the following order:

Upper half of the page → Lower half of the page → Normal size

WALL/ARM MOUNTING

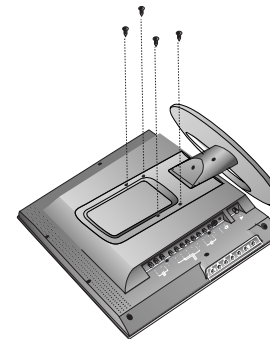

Attaching a Wall or Arm mounting device

This TV supports the VESA mounting standard and will accommodate various VESA mounting devices.

To install any VESA mounting device, please follow the manufacturer's instructions.

1. Remove all cables connected to the TV.
2. Lay the LCD TV face-down on a flat surface with a blanket or other soft materials to protect the screen.
3. Remove the four screws attaching the stand. Remove stand from LCD TV.
4. Now you are ready to install the VESA mounting device suited to your applications (see instructions below).
5. Connect all cables removed at step 1.

Installing VESA compliant mounting devices

1. Align the mounting interface pad (100mm x 100mm hole spacing) with the holes in the television's rear cover mounting pad.
2. Secure bracket with the four screws (4mmØ) that came with the VESA mounting device.

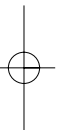
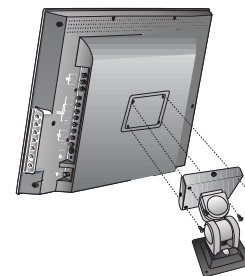

TROUBLESHOOTING

Please check the following items before calling for the repair services.

Problem	Check item	Reference page
TV set		
Control/System lock up	· The TV may have malfunctioned. · Switch your TV off and on again with the main ON/OFF button on the TV Set.	- 12
Remote control does not work.	· Perform control/system lock up reset (as above) · Replace the batteries in the remote controller. · Make sure the Remote sensor window is not under strong light e.g. a fluorescent lamps.	5 -
Local buttons do not work.	· Has the Child lock been switched on?	15
No picture and no sound.	· Check that the TV set is switched on at the main ON/OFF switch.	12
No picture.	· Make sure the brightness and contrast are not set to minimum.	13
No colour	· Make sure the Colour is not set to minimum. · Check the Colour standard settings.	13 11
Picture is too light or too dark.	· Adjust the Brightness, Contrast.	13
The picture is improperly tinted.	· Check the Tint adjustment (NTSC signal)	13
No sound.	· Check that the volume is not set to minimum. · Check sound is not muted. · Make sure headphones are not connected.	14 14 6
Aerial		
The picture is not sharp. The picture shakes.	· Reception may be weak. · The quality of the broadcast may also be poor. · Make sure the aerial is facing the correct direction. · Check that the outside aerial is not disconnected.	
The picture is ghosted.	· Mountains or high buildings can cause double pictures. · Try changing the direction of the aerial.	
The picture is spotted(snow).	· There may be interference from automobiles, trains, high voltage lines, neon lights, etc. · There may be interference between the aerial cable and power cable · Try positioning cables further apart.	
Picture has lines and faded colours.	· Transmission aerial of amateur radios and cellular phones may cause interference. · Position the TV set as far away as possible from devices that may cause interference.	

PRODUCT SPECIFICATIONS

Display	
Lamp type	CCFL
Panel type	20.1"(50.9 Cm), 4:3 aspect ratio TFT LCD (LG-Philips LCD)
Pixel resolution	921,600 dots (640x480,VGA)
Brightness	400cd/m ² , 450cd/m ² (Only for IPS model)
Viewing angle	120V/140H 170V/170H(Only for IPS model)
TV standards	
TV standards	PAL-BG/DK/1 SECAM-BG/DK/L NTSC (AV)
Sound system	A2-BG/DK NICAM-BG/DK/1/L
Reception channel	<ul style="list-style-type: none"> · VHF : E2(48.25)-E4(62.25), E5(175.25)-E12(224.25) · UHF : E21(471.25)-E69(855.25) · Cable : S1'(69.25)-S3'(83.25), S1(105.25)- S41(463.25)
Mains	
Mains voltage	100-240V AC, 50/60Hz
Power consumption	<ul style="list-style-type: none"> · Stand-by : 3W max. · Operating : 65W
Sound	
Sound output	2.0 W x 2
Loudspeaker	3 W norm. 72x48mm x 2
Teletext (Option)	
Fastext	10 pages memory TOP/FLOF
Teletext language	Pan-European, Cyrillic, Greek/Turkish, Arabic /French (Option)
Connections	
Terminals	<ul style="list-style-type: none"> · Antenna (RF) : DIN type · RCA (Video/Audio in) · S-Video (Y/C in) · RCA (Y/Pb/Pr in) · SCART (R/G/B in, Video/Audio in/out) · Headphone : 3.5mm ø
Mechanical spec.	
Dimension (mm)	<ul style="list-style-type: none"> · With Box : 695x550x258 (W x H x D) · Set - With stand : 608x475x185 (W x H x D) · - Without stand : 608x396x65 (W x H x D)
Weight (Kg)	<ul style="list-style-type: none"> · With Box : 12.5 · Set - With stand : 9.2 · - Without stand : 7.9
Table stand	<ul style="list-style-type: none"> · Tilt : 5 ° forward, 15 ° backward · Swivel : 45 °
Wall mounting	VESA compatible

* Specifications are subject to change without notice.

HELPLINE NUMBER 0870 100 2525

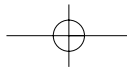

MEMO

MEMO

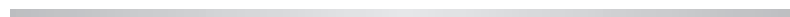
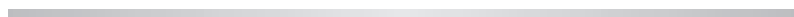
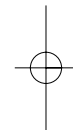
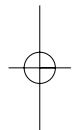

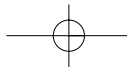

MEMO

